

# WÖHLER

Manual  
Leakage Tester

## Wöhler DP 600



Art. n° 22915 – 2014/03/25

*The Measure of Technology*

# Contents

<b>1</b>	<b>General Information .....</b>	<b>4</b>
1.1	Operation Manual Information .....	4
1.2	Notes .....	4
1.3	Intended Use .....	4
1.4	Components .....	5
1.5	Transport .....	5
1.6	Information on disposal .....	5
1.7	Manufacturer .....	5
<b>2</b>	<b>Technical Data .....</b>	<b>6</b>
<b>3</b>	<b>Component explanation .....</b>	<b>8</b>
3.1	Device .....	8
3.2	Adapter .....	9
3.3	Display .....	10
3.4	Necessary accessories .....	12
3.4.1	Sealing Set for chimneys Class N .....	12
3.4.2	Sealing Set for chimneys Class P + H .....	12
3.5	Function .....	14
3.5.1	Measurement principle .....	16
<b>4</b>	<b>Menu navigation .....</b>	<b>17</b>
4.1	Main menu .....	17
4.2	Overview sub menus .....	18
<b>5</b>	<b>Leakage test of exhaust gas systems ..</b>	<b>21</b>
5.1	Installing the device .....	21
5.2	Preparing the control of an exhaust gas system class P or H .....	22
5.3	Preparing the control of an exhaust gas system class N .....	24
5.3.1	Assembling the Probe Class N .....	24
5.3.2	Installation of the probe in the exhaust gas system (chimney) .....	27
5.4	Turning on the Wöhler DP 600 .....	27
5.5	Leakage test in normal mode .....	28
5.6	Manual Mode .....	32

5.7	Variable Mode.....	33
<b>6</b>	<b>Differential pressure.....</b>	<b>33</b>
<b>7</b>	<b>4 PA-Test.....</b>	<b>34</b>
7.1	Preparations for the 4 Pa test .....	34
7.2	Performing the 4 Pa test .....	37
<b>8</b>	<b>Stove Test .....</b>	<b>39</b>
8.1	Performing the Stove Test .....	39
<b>9</b>	<b>SETUP.....</b>	<b>40</b>
<b>10</b>	<b>Data management.....</b>	<b>42</b>
10.1	Save customer records .....	42
10.2	Creating a new customer folder .....	43
10.3	Option "Data management" .....	43
<b>11</b>	<b>Data transfer with the PC or notebook. .....</b>	<b>44</b>
<b>12</b>	<b>Calibration.....</b>	<b>44</b>
<b>13</b>	<b>Info.....</b>	<b>44</b>
<b>14</b>	<b>Fault indication .....</b>	<b>45</b>
<b>15</b>	<b>Maintenance.....</b>	<b>45</b>
15.1	Maintenance work.....	46
<b>16</b>	<b>Warranty and Service .....</b>	<b>47</b>
16.1	Warranty .....	47
16.2	Service.....	47
<b>17</b>	<b>Accessories .....</b>	<b>48</b>
<b>18</b>	<b>Declaration of Conformity.....</b>	<b>49</b>
<b>19</b>	<b>Brief instruction: Leakage Test .....</b>	<b>50</b>
	<b>Points of sale and service .....</b>	<b>51</b>

# 1 General Information

## 1.1 Operation Manual Information

This operation manual allows you to work safely with the Wöhler DP 600 Leakage Tester. Please keep this manual for your information.

The Wöhler DP 600 Leakage Tester should be employed by professionals for its intended use only.

Liability is void for any damages caused by not following this manual.

## 1.2 Notes



### **WARNING!**

Not following this warning can cause injury or death.



### **ATTENTION!**

Not following this note can cause permanent damage to the device.



### **NOTE!**

*Useful information*

## 1.3 Intended Use

The Wöhler DP 600 Leakage Tester controls the tightness of all exhaust gas systems listed in EN 1443 by measuring the air flow required to maintain the test pressure level.

The instrument is also suitable for the 4 Pa test (standard method and enhanced method) according to the DVGW (German Association of Gas and Water Engineers) sheet G 625 (2009). The 4 Pa Pressure Test is a simple control of the underpressure limit 4 Pa which informs whether there is sufficient combustion air supply or not. No auxiliary measuring instrument will be necessary.

The device is suitable to control the tightness of fireplaces. The DP 600 measurement is based on the approval principles for non-roomsealed heating appliances, published by the German Institute for Building Technology (Deutsches Institut für Bautechnik) in July 2002.

Do not use the device for any other use than set out in this manual.

## 1.4 Components

Device	Components
Wöhler DP 600	Leakage Tester
	Power cable
	Adapter 0,3 Adapter 3,0

## 1.5 Transport



### ATTENTION!

Improper transport can harm the instrument.

Always transport the instrument in the provided carrying case in order to prevent damage.

The case is included in the sets and also can be bought separately.

## 1.6 Information on disposal

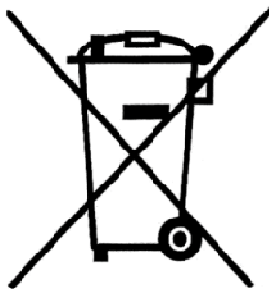

Electronic equipment does not belong into domestic waste, but must be disposed in accordance with the applicable statutory provisions.

You may hand in any defective batteries taken out of the unit to our company as well as to recycling places of public disposal systems or to selling points of new batteries or storage batteries.

## 1.7 Manufacturer

### Wöhler Messgeräte Kehrgeräte GmbH

Schützenstr. 41

33181 Bad Wünnenberg

Tel.: +49 2953 73-100

Fax: +49 2953 7396-250

E-Mail: mgkg@woehler.com

## 2 Technical Data



**NOTE!**

*The volume flow here indicated refers to a tension of 230V. If the tension is lower, the volume flow will be reduced.*

<b>Pressure</b>	
Range	0 to 7000 Pa
Resolution	0,1 Pa from 0,0 to 900,0 Pa 1 Pa from 900 Pa on
Accuracy	± 0,5 Pa, ± 2,5 % of reading
<b>Volume flow without adapter</b>	
Range	0,0 to 200,0 Nm <sup>3</sup> /h
Resolution	0,1 Nm <sup>3</sup> /h
Accuracy	± 2,5 Nm <sup>3</sup> /h, ± 5 % of reading
<b>Volume flow with adapter 3,0</b>	
Range	0,00 to 10,00 Nm <sup>3</sup> /h
Resolution	0,01 Nm <sup>3</sup> /h
Accuracy	± 0,05 Nm <sup>3</sup> /h, ± 5 % of reading
<b>Volume flow with adapter 0,3</b>	
Range	0,10 to 18,00 NL/min (0,006 to 1,080 m <sup>3</sup> /h)
Resolution	0,01 NL/min
Accuracy	± 0,05 NL/min, ± 5 % of reading

<b>General technical data</b>	
Power supply	110 to 230 V, 50 to 60 Hz
Size	33 x 36 x 15 cm
Weight	9,2 kg

### 3 Component explanation

#### 3.1 Device

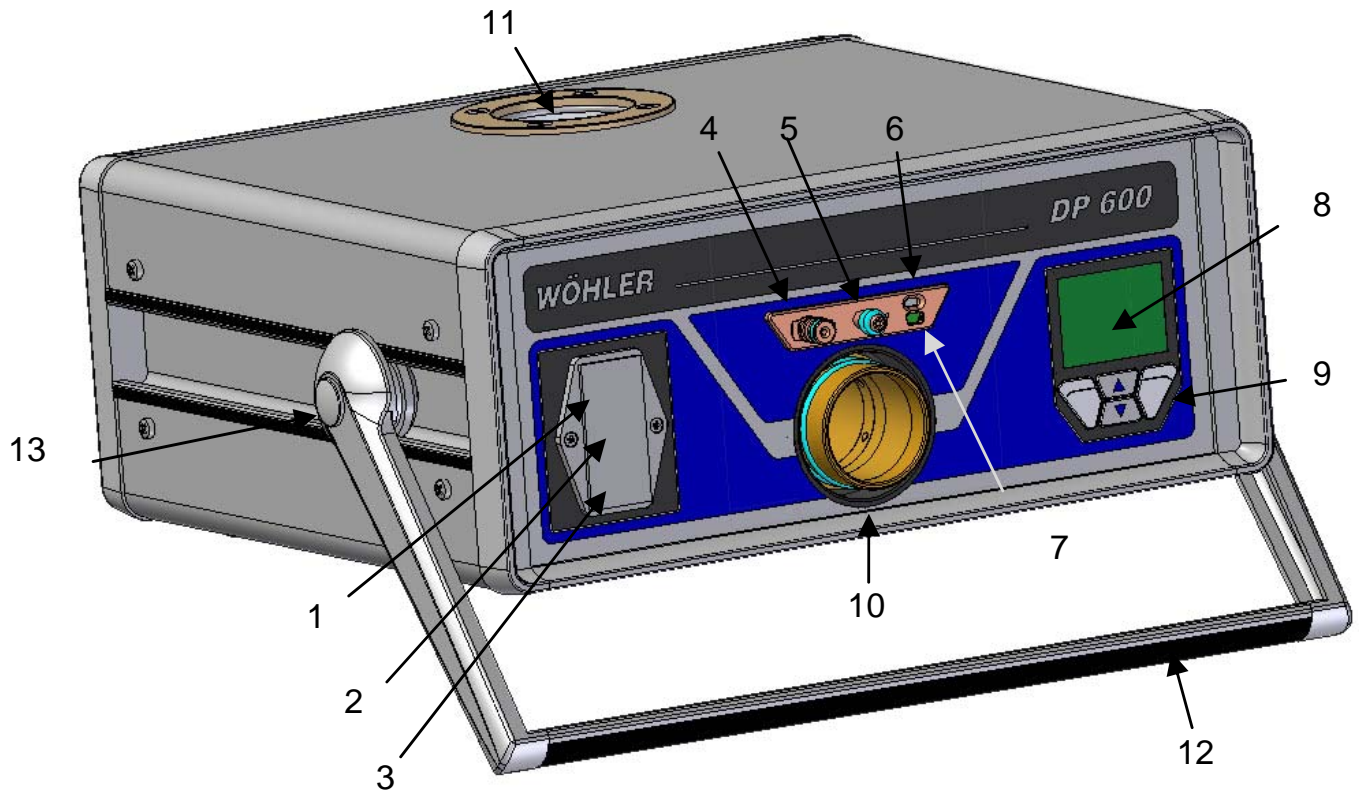

Fig. 1: Overview

- |   |  |    |   |
|---|--|----|---|
| 1 | On/Off switch  | 7  | USB port  |
| 2 | Power supply connection  | 8  | Color display   |
| 3 | Fuse switch<br>(Microfuse T10, 250 V)  | 9  | Keypad  |
| 4 | Pressure connection (over-<br>pressure) with plug-in con-<br>nector          | 10 | Air connection - over pressure (without<br>adapter)         |
| 5 | Differential pressure con-<br>nector (under pressure) with<br>tube connector | 11 | Air connection - under pressure                             |
| 6 | Infrared interface for Wöhler<br>TD 100.                                     | 12 | Pivoting carrier  |
|   |  | 13 | Pressure point for adjusting the carrier<br>(on both sides) |



## 3.2 Adapter

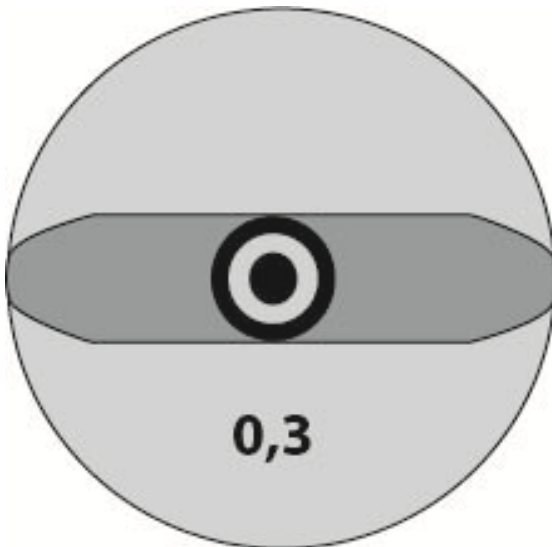

Fig. 2: Adapter 0,3

The Wöhler DP 600 features a wide measuring range of the volume flow. Two different adapters are necessary to guaranty the specified accuracy of the volume flow measurement.



### NOTE!

*The instrument does not recognize automatically if an adapter is inserted or not.*

The adapter 0,3 has to be inserted into the air connection (over pressure) (Fig. 1, part 10), when exhaust gas systems class P + H have to be controlled with small volume flows.

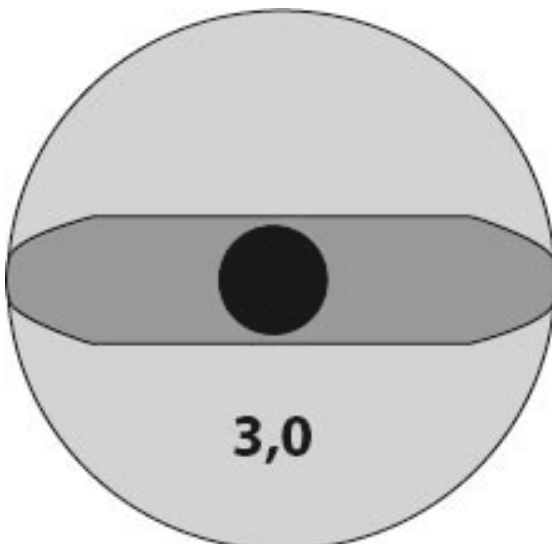

Fig. 3: Adapter 3,0

The adapter 3,0 has to be inserted into the air connection (over pressure) (Fig. 1, part 10) when measurements with volume flows 0,00 to 10,00 Nm<sup>3</sup>/h have to be done, for example for a stove test.

No adapter is used for measurements with volume flows 0 to 200 m<sup>3</sup>/h at exhaust gas systems class N.

### 3.3 Display



The Wöhler DC 600 has a color display with a diagonal of 6 cm. The OLED-technology allows reading the display from almost any angle of view.

The Wöhler DP 600 is operated using four multiple function keys.

Escape      Scroll/change values      OK / NEXT / STOP

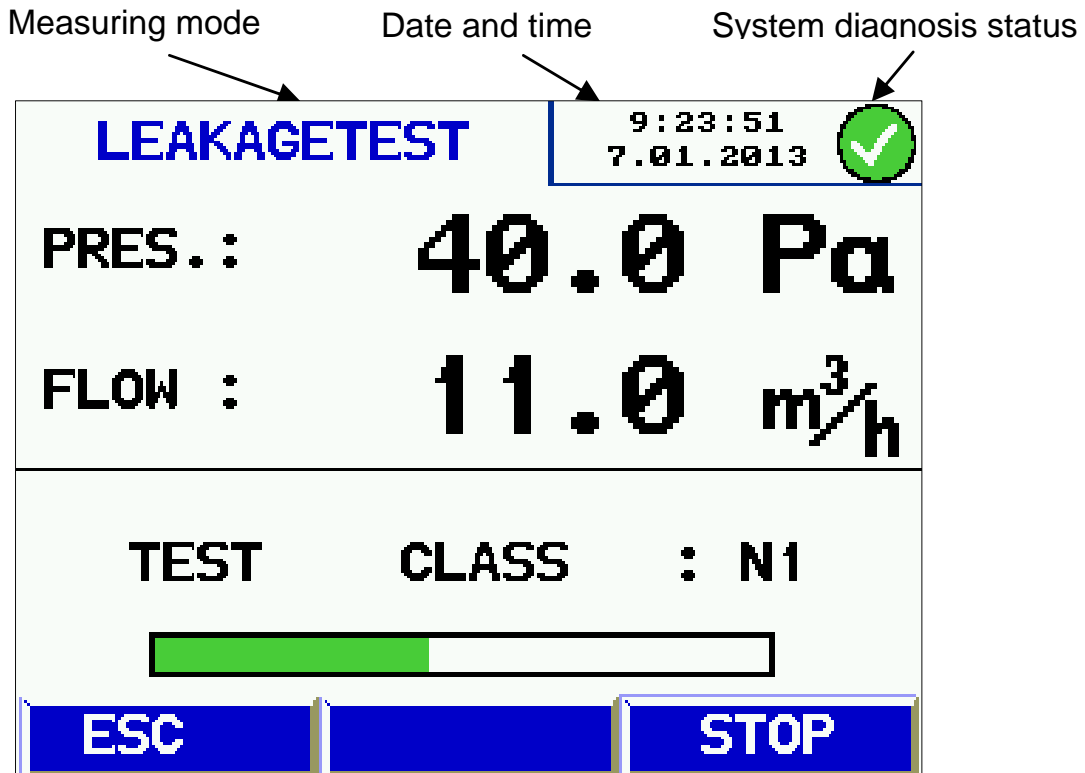

The display is divided into a status, a menu and a readings segment.

The currently selected mode or menu is shown in the left status segment.

- Date and time and the system diagnosis status are shown in the status segment on the right.

The readings segment displays the readings or the menu items.

The menu segment is situated at the bottom of the display. It consists of three soft keys.

### 3.4 Necessary accessories

Probes, tubes, sealing bladders and sealing elements are not included, but can be purchased as accessories. As there are many different types of exhaust gas systems, in specific cases it may be necessary to adapt the sealing elements.

#### 3.4.1 Sealing Set for chimneys Class N

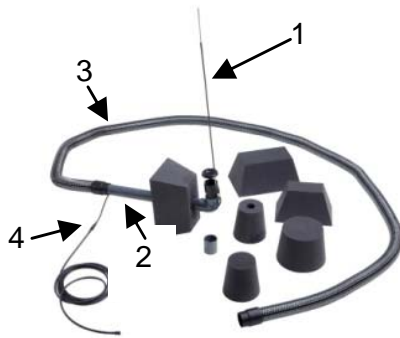

Fig. 5: Sealing Set Class N

The Sealing Set Class N is necessary for measurements on chimneys Class N. The set includes a Probe Class N (1), an extension tube (2), a straight sleeve and an angled sleeve, an air tube, 4 m (3), a pressure tube 4 m (4) and different sealing elements.

The user can purchase Sealing Elements of many different forms and sizes. Nevertheless it may be necessary to adapt the Sealing Element to the exhaust gas installation or the chimney. In this case we recommend to use Sealing Elements that can be cut individually. (see accessories).

#### 3.4.2 Sealing Set for chimneys Class P + H



Fig. 6: Sealing Set Class P + H

For the control of exhaust gas systems of class P and H two hoses, a Sealing Bladder with gas lead through, a Sealing Bladder without gas lead through and a ball pump are necessary.



**NOTE!**

*The necessary accessories can be purchased in a set.*

Generally exhaust gas systems of class P and H are round stainless steel tubes. Sealing round exhaust ducts with a Sealing Bladder is easy and safe. Different Sealing Bladders up to Ø 600 mm can be purchased.

Nevertheless, exhaust gas systems can have many different forms, so that it may be necessary to create a sealing system for the installation to be controlled.



**NOTE!**

*Sealing systems adapted to a certain installation must fulfill many requirements. All questions concerning the sealing should be addressed to*

*Wöhler (see manufacturer's address in chapter 1.7).*

When controlling exhaust gas systems of class H, the measurement is done with a test pressure of 5000 Pa. Therefore it is absolutely necessary to fix the Sealing Bladder so that it cannot be moved or blown. For this purpose, the Sealing Bladder can be fixed at the beginning or the end of the test section with a reinforced adhesive tape or with load securing nets.

The result of the measurement will only be exact, when the position of the Sealing Bladder has not changed during the measurement.

- Mark the position of the Sealing Bladder with a pencil before starting the measurement.

### 3.5 Function

The Wöhler DP 600 controls the tightness of exhaust ducts and chimneys. A menu enables the user to select between the different installation classes. The Wöhler DP 600 regulates automatically the pressure which is necessary to control the flue gas systems classes P, H and N and determines the leakage rate automatically.

Description of the exhaust gas system	Classification Type	Test pressure	Maximum allowable leakage rate per m <sup>2</sup> inner surface
Exhaust gas system negative pressure operation (chimney)	N1	40 Pa	7,20 m <sup>3</sup> /h
	N2	20 Pa	10,80 m <sup>3</sup> /h
Exhaust gas system overpressure operation (Exhaust pipe)	P1	200 Pa	0,36 l/min (0,022 m <sup>3</sup> /h)
	P2	200 Pa	7,20 l/min (0,432 m <sup>3</sup> /h)
Exhaust gas system high pressure operation (block heat and power plant)	H1	5000 Pa	0,36 l/min (0,022 m <sup>3</sup> /h)
	H2	5000 Pa	7,20 l/min (0,432 m <sup>3</sup> /h)

Table of the classes of exhaust gas systems according to EN 1443 (DIN 18160)

The Wöhler DP 600 can also be used to control the tightness of a stove. According to the approval guidelines concerning the evaluation of room sealed heating applications the following requirements apply for the tightness of the heating application with the necessary connecting pipe for the combustion air and the connecting piece.

Description of the exhaust gas system		Test pressure	Maximum allowable leakage rate	
solid-fuel fireplaces		10 Pa	2,0 m <sup>3</sup> /h	
oil fireplaces	Fireplaces with connections	completely air flushed	50 Pa	5,0 m <sup>3</sup> /h
		partly air flushed	50 Pa	1,0 m <sup>3</sup> /h
	fireplace only	completely air flushed	50 Pa	3,0 m <sup>3</sup> /h
		Partly air flushed	50 Pa	0,6 m <sup>3</sup> /h

With the Wöhler DP 600 Leakage Tester the 4 Pa-test to control the underpressure limit 4 Pa can be performed. The 4 Pa test controls if there is a sufficient combustion air supply according to the DVGW (German Association of Gas and Water Engineers) Note G 625. No additional measuring instrument will be necessary for the 4 Pa test. The test measures the differential pressure between the room and the ambient air during the operation of the fireplace (standard method) or when the theoretically required combustion air is withdrawn (enhanced method).

### 3.5.1 Measurement principle

The seal on exhaust gas systems is measured by inflating the line to a constant overpressure and measuring the volume flow required to maintain the overpressure.

The following diagram shows the principle of the measurement configuration. The volume flow generated by means of two turbine blowers is fed into the sealed exhaust gas system by means of a hose. As a result of incoming air, the pressure in the exhaust system rises. This pressure is fed back to the measuring device via a second hose. The turbine blowers are regulated by comparing the preset test pressure with the actual test pressure in the exhaust gas system.

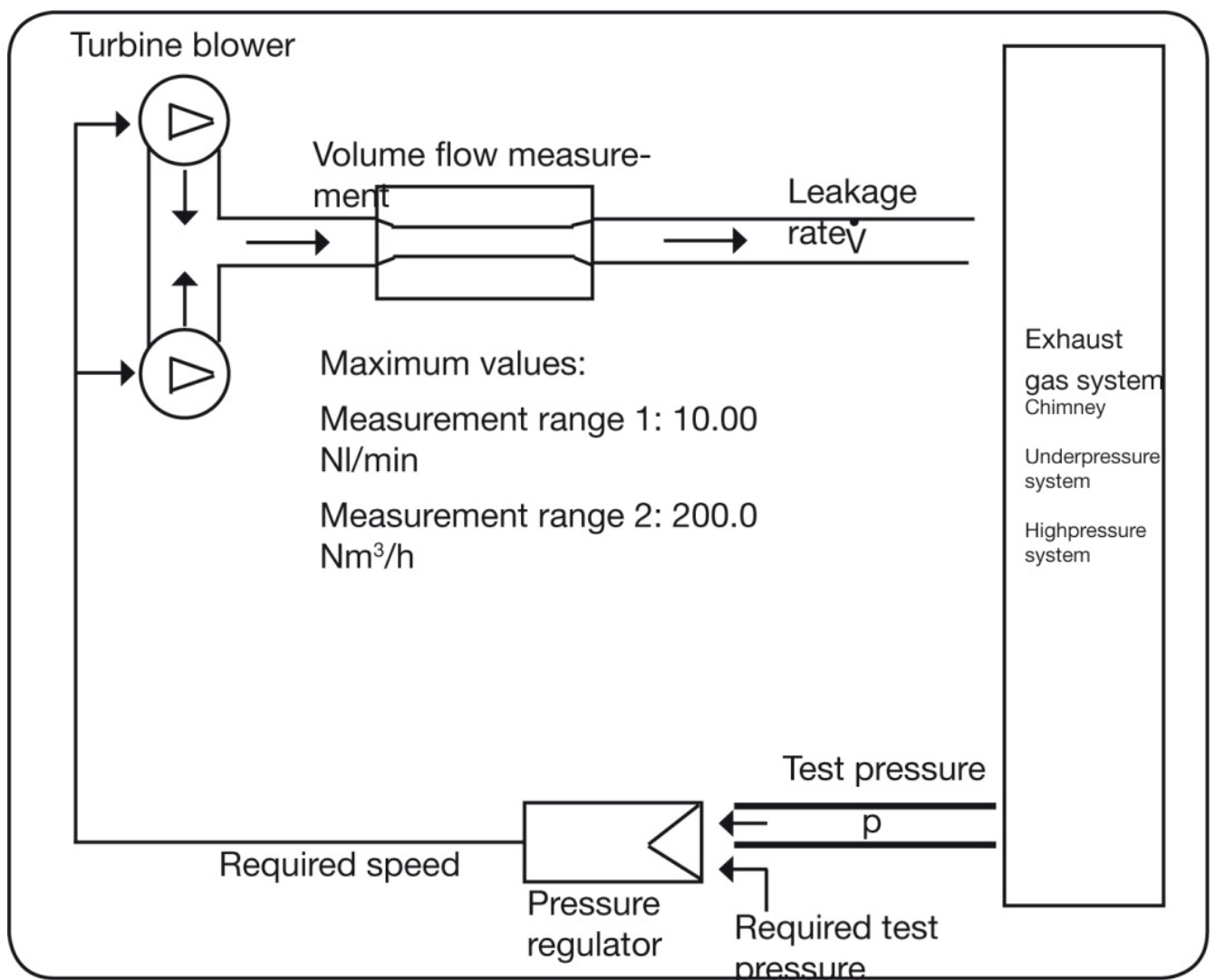

Fig. 7: Measuring principle Wöhler DP 600



## 4 Menu navigation

### 4.1 Main menu

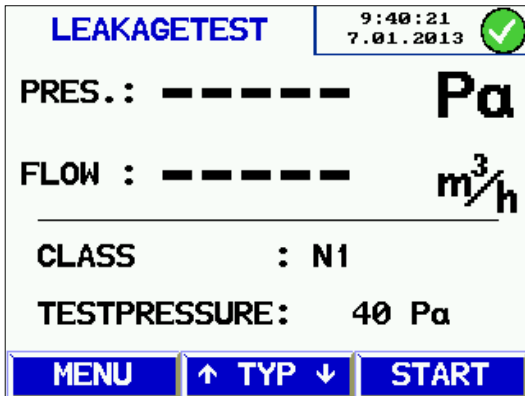

Fig. 8: Opening screen

Immediately after the Wöhler DP 600 has been switched on, the version and afterwards the opening screen are displayed (see figure on the left).

To activate the main menu, press menu when the opening screen is displayed. In the main menu, all submenus and applications can be activated. The following menus are available:

- Print
- Save
- Data management
- Exhaust Gas System Class
- Manual Mode
- Variable Mode
- Differential Pressure
- 4 Pa - Test
- Stove Test
- SETUP
- Calibration
- Info

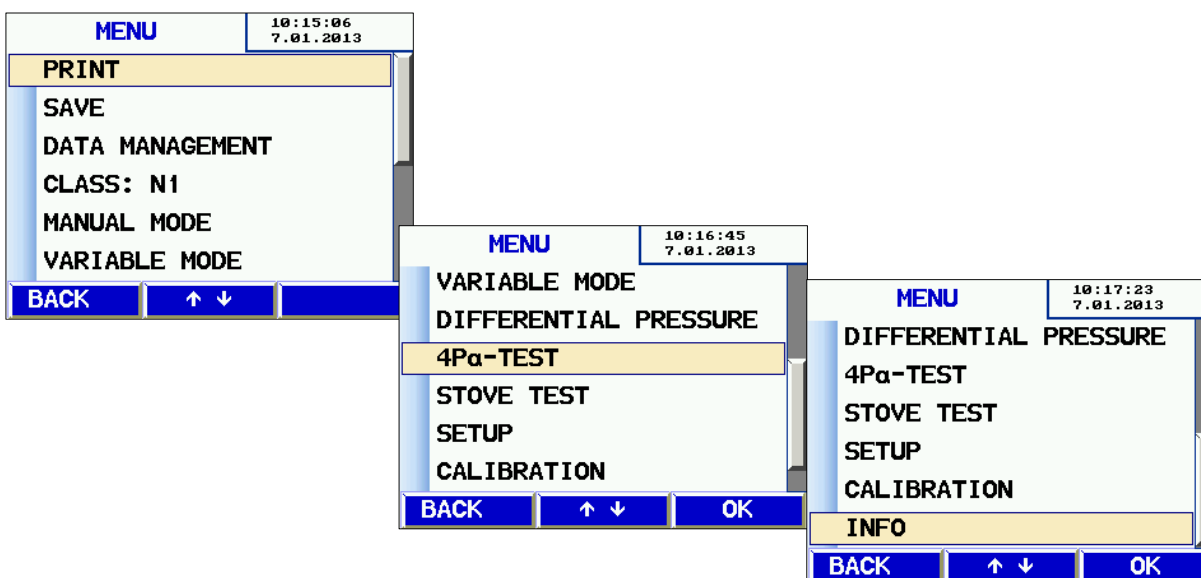

Fig. 9: Main menu

## 4.2 Overview sub menus

Menu	Sub menus	Contents and Notes
Print		Transfer data to the thermo printer via an infrared port
Save	New customer > create a new customer	Relate the measured data to a customer and save
Data management	Print	Print the saved measurement results later
	Delete riser	Delete a single riser
	Delete customer	Delete all records of a single customer
	Delete all customer records	
Exhaust Gas System Class	N1: 40PA	Select the exhaust gas system class  (The most common classes N1, P1 and H1 can be selected directly in the leakage test menu).
	P1: 200 Pa	
	H1: 5000 Pa	
	N2: 20 Pa	
	P2: 200 Pa	
	H2: 5000 Pa	

Manual Mode	Same as Leakage Test	The user selects the adapter and controls the volume flow. Intended for experienced users only.
Variable Mode	Same as Leakage Test	The user selects the adapter and controls the volume flow and selects the limit value. Intended for experienced users only.
Differential Pressure Diagram	Printing out measurement records	Diagram: differential pressure during the last four minutes
	(It is not possible to save the diagram)	
4 PA-Test	Standard method	Control if sufficient supply of combustion air is assured.
	Enhanced method	
Stove Test	Same as Leakage Test class N	Measures the leakage rate of the tested stove Always with Adapter 3,0

## Menu navigation

<b>SETUP</b>	<b>Date</b>	
	Time	Time
	Brightness	Backlight
	Units	Pa, hPa, mbar, mm/H <sub>2</sub> O, in/Wc
	Auto Mode	Select between normal mode or the last mode that was especially configured.
	Controller	Normally the user should not change this parameter.
	Factory Reset	Reset all settings to their factory default.
	Printer logo	Enter the logo of the society.
Calibration		Calibration menu locked by a keyword Only authorized Service points may calibrate the device.
Info	Cycles	
	Hours	
	Date of manufacture	
	Date of calibration	
	Firmware version	

## 5 Leakage test of exhaust gas systems



### WARNING!

Before starting the measurement, switch off the heating system!

### 5.1 Installing the device



Fig. 10: Pressure point for adjusting the carrier

- Place the Wöhler DP 600 on a dry and flat surface and ensure a secure position.
- Adjust the carrier to a position that is favorable for you. Press the two pressure points (Fig. 1, point 13) to change the position.

Four positions of the carrier are possible.

- Afterwards connect the probes and hoses which are necessary for the measurement and seal the test object as described in the following chapters.

## 5.2 Preparing the control of an exhaust gas system class P or H

You need a Sealing Set Class P + H, see chapter 3.4.2

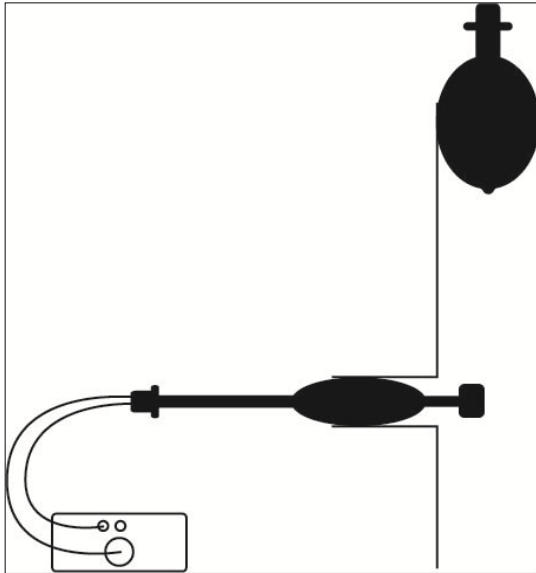

- Seal the top of the exhaust duct with a Sealing Bladder. The Sealing Bladder must be without gas lead through and its nominal size must match with the diameter of the exhaust gas system.
- Insert the Sealing Bladder with a double gas lead through into the exhaust gas system. Plug the ball pump on the smallest connector and inflate the Sealing Bladder until it is fixed in the nozzle. Remove the ball pump.



### NOTE!

*There can be significant amounts of condensate in the exhaust gas system. Make sure that the Sealing Bladder is not placed in the condensate, because this may result in damage to the device.*

Fig. 11: Schematic drawing of an exhaust duct (stainless steel)



Fig. 12: Connection of the pressure tube and the air tube to the Wöhler DP 600



Fig. 13: Connection of the ball pump, the pressure tube and the air tube

- Connect the hoses to the Wöhler DP 600 as follows:
  - Place the adapter 0,3 in the air connection (over pressure) (Fig. 1, part 10).
  - Plug the air tube on the connector of the adapter.
  - Plug the free end of the air tube to the connector of the Sealing Bladder marked by an arrow that points to the exhaust gas system.
  - Plug the pressure tube on the overpressure socket (+) (Fig. 1, position 4).
  - Plug the free end of the pressure tube to the connector of the Sealing Bladder marked by an arrow that points away from the exhaust gas system.



**NOTE!**

Fix the Sealing Bladder so that it cannot get out of place during the measurement, especially when measuring an exhaust gas system of class P with a diameter > 150 mm and when measuring an exhaust gas system of class H. The result of the measurement will only be correct, when the position of the Sealing Bladder has not changed during the measurement. You can easily control the position of the Sealing Bladder in the exhaust gas duct by marking it with a pen before the measurement.

### 5.3 Preparing the control of an exhaust gas system class N

You need a Sealing Set Class N, see chapter 3.4.1.

#### 5.3.1 Assembling the Probe Class N

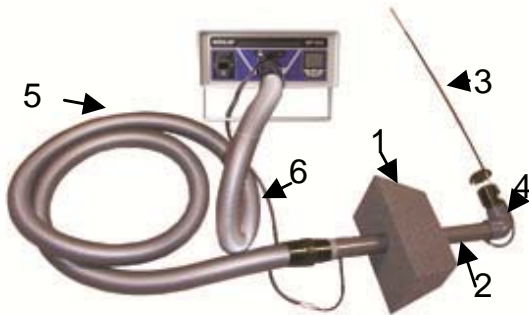

- Plug a Sealing Element with hole (1) on the extension pipe (2).
- Connect the probe (3) to the elbow connector (4).
- Connect the elbow connector via the extension pipe (2) to the plastic hose (5).

Fig. 14: Assembling the Probe Class N



Fig. 15: Extension pipe end with wide O-ring - hose connector



Fig. 16: Extension pipe end with narrow O-ring - probe connector



**NOTE!**

Plug the hose to the end with the wide O-rings and the elbow connector to the end with the narrow O-rings.





- Plug the free end of the plastic hose (5) to the air connection (over pressure) (Fig. 1, part 10).



**NOTE!**

*Do not install any adapter when controlling exhaust gas systems class N.*

*Fig. 17: Hoses and cable connected to the measuring instrument for the leakage test class N: Mains cable, pressure hose and plastic hose*



- There is a small hose fixed to the upper end of the extension pipe. Plug the connector of that hose to the jack of the probe, see figure 18.
- Plug the hose fixed to the bottom of the extension pipe to the pressure hose that is connected to the DP 600, see fig. 19.
- Connect the pressure hose (6) to the over-pressure socket (+) (Fig. 1, position 4).

*Fig. 18: Probe connected to the extension pipe.*



*Fig. 19: Extension hose connected to the pressure hose.*

### 5.3.2 Installation of the probe in the exhaust gas system (chimney)

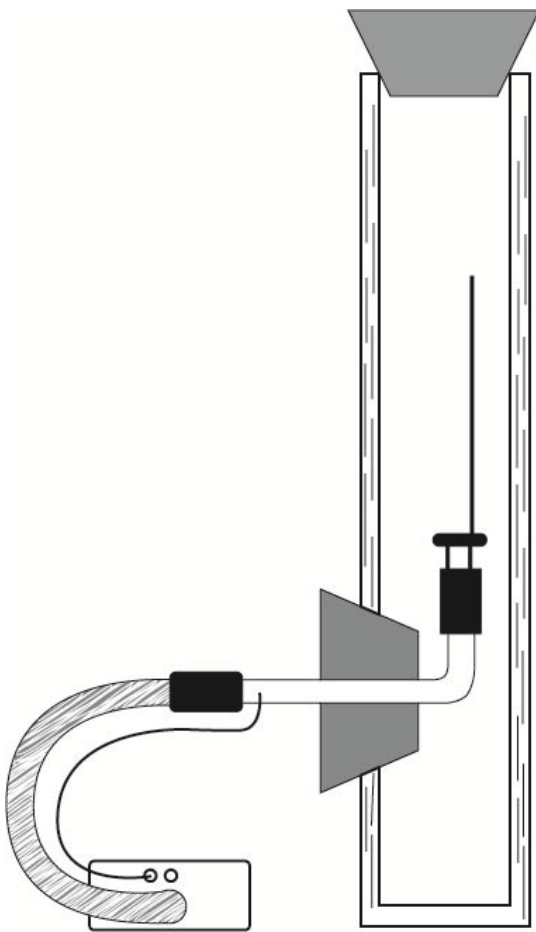

- Carefully insert the probe through the cleaning aperture into the chimney, see schematic drawing.
- Take care that the Sealing Element seals the cleaning aperture totally.
- Seal the top of the chimney with a sealing element without hole.

Fig. 20: Schematic drawing of a brick lined chimney

### 5.4 Turning on the Wöhler DP 600

- After all necessary accessories have been connected to the Wöhler A 600 as described, connect the power cord to the instrument and plug it into an outlet.



#### **WARNING!**

#### **Risk of electrical shock!**

The Wöhler DP 600 is supplied with a voltage of 230 VAC. Coming in contact with live parts can be lethal.

Never touch the power supply with wet hands!

Do not unplug the power supply by pulling the cable!

Do not use the device when the voltage requirements of the device and the supply do not match!

- Switch on the Wöhler DP 600.

## 5.5 Leakage test in normal mode

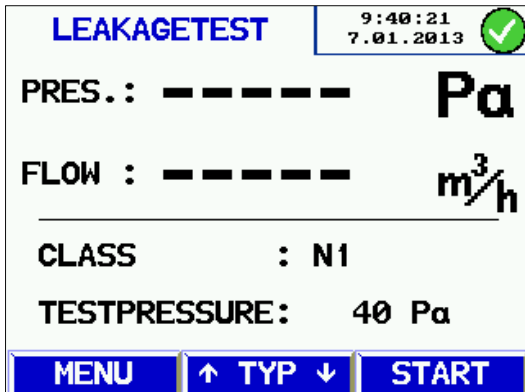

Fig. 21: Leakage test of exhaust gas installations class N1

5 seconds after the device has been switched on the version is displayed.

After that the display "Leakage test" appears.

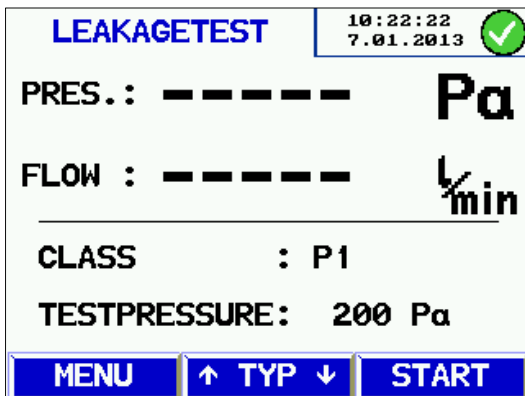

Fig. 22: Leakage test of an exhaust gas installation class P1

- Press the arrow keys to select the class. In this mode, the standard installations class N1, P1 and H1 can be selected.



**NOTE!**

All other installation classes can be selected in the menu "Class"



**NOTE!**

In normal mode, the last installation class selected will be displayed.

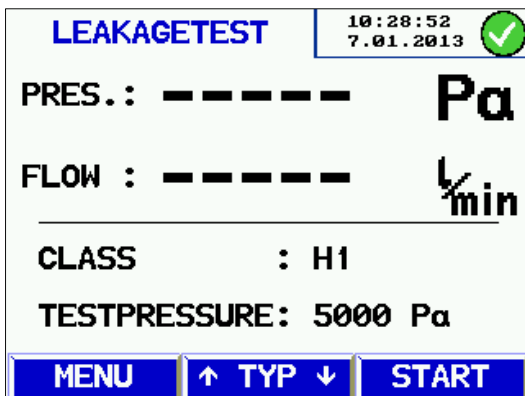

Fig. 23 Leakage test of an exhaust gas installation class H1

The necessary test pressure according to EN 1443 will be indicated depending on the selected installation class.

Furthermore, the indicated volume flow will change automatically to the correspondent unit.



**NOTE!**

Make sure that the correct adapter has been installed (see chapter 3.2). The instrument does not recognize automatically if an adapter has been installed or not.

## Self test

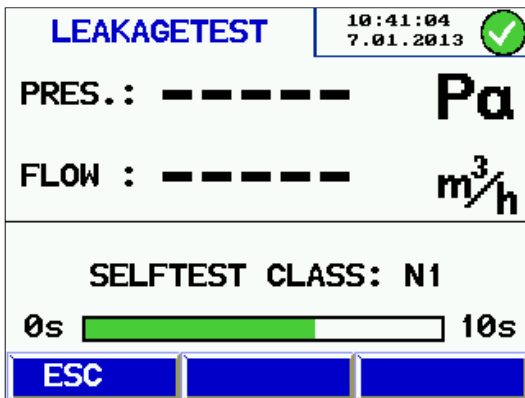

Fig. 24: Self test

## Display during the measurement

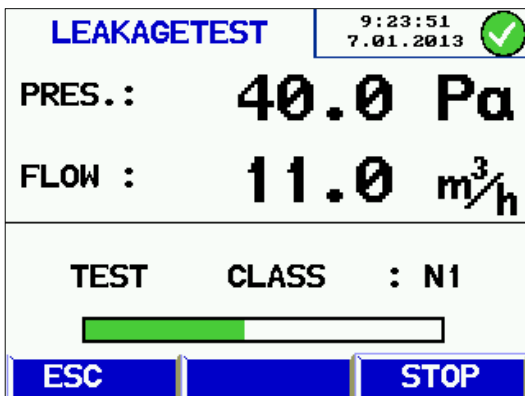

Fig. 25: running measurement

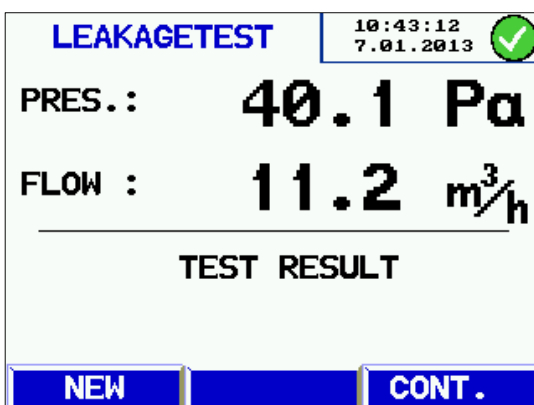

Fig. 26: Result display

- Press "Start" to start the measurement.

The Wöhler DP 600 will automatically start a self test to control the internal probes. The self test takes 10 sec. The test also checks if the exhaust gas system is at normal pressure and if there are any pressure variations. After that the Wöhler DP 600 will automatically start the measurement.

Now the Wöhler DP 600 creates the test pressure. When the test pressure is reached, the measurement will start automatically. During the measurement the currently measured volume flow is indicated. As soon as the readings have stabilized, the Wöhler DP 600 will perform the measurement automatically and finish the test after that.

**! ATTENTION!**

After measurements of Class P and H the note **Test Finished** will appear. Unplug the air tube to prevent that condensation water is pressed from the exhaust gas installation into the measuring instrument.

The result is shown in the display.

**☞ NOTE!**

*The result corresponds to the leakage rate of the exhaust gas system.*

- Press **New** to return to the measurement menu and start a new measurement where required or
- Press **Cont. (continue)** to bring up the evaluation.

Evaluation

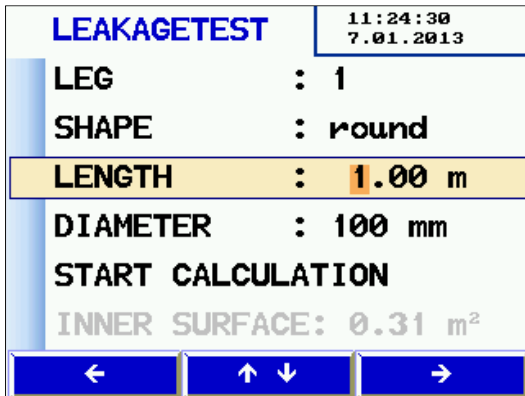

Fig. 27: Entering the cross section area:

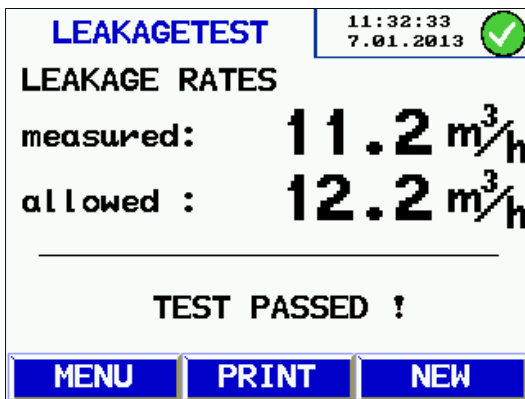

Fig. 28: Evaluation of the measurement results (Class N)

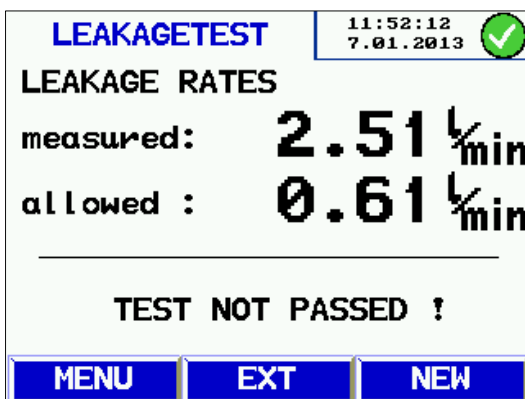

Fig. 29: Evaluation of the measurement results (Class P or H)

- Enter the cross section area. Proceed as follows:  
With the up and down keys go to the parameter to be changed, confirm your selection with the right key and enter the value with the up and down keys.

Shape, length and diameter can be entered for three sections. The Wöhler DP 600 will calculate the cross section area automatically.

- Select **Start evaluation** and confirm with **OK**.  
The measured leakage rate, the maximum allowed leakage rate according to EN 1443 and an evaluation (**TEST PASSED** or **TEST NOT PASSED**) will be displayed.

For measurements of exhaust gas installations of class P and H the following applies:

If the measured leakage rate is higher than the allowed leakage rate, an additional measurement (extended procedure) can be performed.

- To do so, press **Ext**.  
The Wöhler DP 600 will now blow an airflow corresponding to the permissible leakage rate into the exhaust gas system and measure the pressure that the air has created in the exhaust gas system. The result will be shown in the display. The user has the following possibilities now:

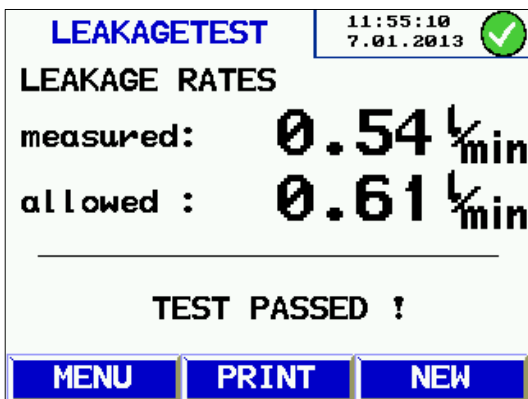

Fig. 30: Evaluation of the measurement results (exhaust gas system OK)

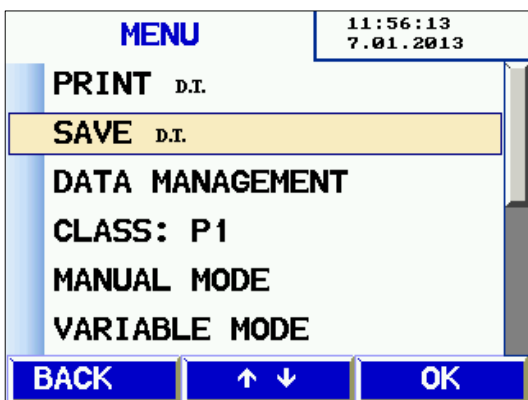

Fig. 31: Main menu after the density test has been performed.

- Press **Menu** to return to the measuring menu again.
- Press **New** to start a new measurement.
- Press **PRINT** to print the measurement result on the Wöhler TD 100 Thermoprinter.
- Press **Menu > SAVE** to save the measurement (see chapter.10).
- After the measurement; D.T. (density test) will appear next to the submenus **Print** and **Save**. So it is obvious that the density test has already been done.

## 5.6 Manual Mode

In the manual mode, the measurement can be done without an automatic control of the test pressure. In this mode the volume flow is controlled by the user. The user is free to choose the adapter.



**NOTE!**

*Only experienced users should use this mode.*

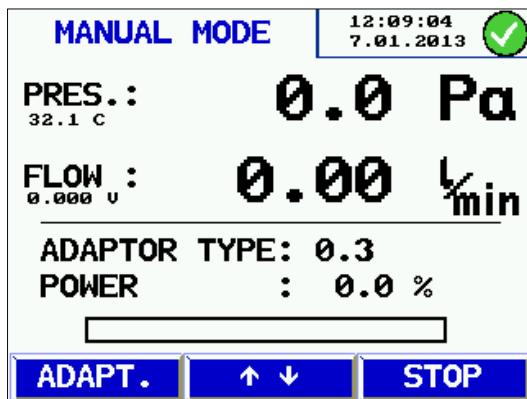

Fig. 32: Manual Mode

- In normal mode, press **menu** to call up the main menu.
- Select **MANUAL MODE** and confirm with the right key.
- The Wöhler DP 600 will perform a self test and afterwards go to the manual mode menu.



**NOTE!**

*It is necessary to use the suitable adapter so that the specification of the volume flow is correct.*

- Press **STOP** to return to the measuring menu again.



## 5.7 Variable Mode

In the variable mode the user can choose the test pressure and the limit value.



**NOTE!**

Only experienced users should use this mode.

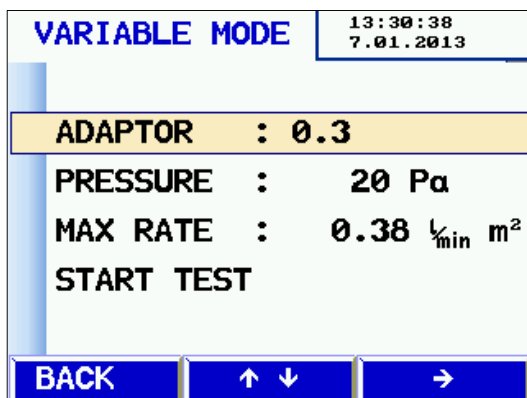

Fig. 33: Variable Mode

- In normal mode, press **menu** to call up the main menu and select **VARIABLE MODE**.
- With the right key select the adapter.
- Go to **PRESSURE** with the down key and enter the test pressure.
- Go to the **MAX RATE** with the down key and enter the limit value.

## 6 Differential pressure

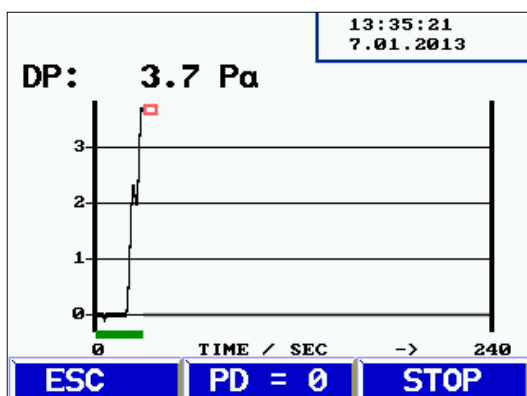

Fig. 34: Differential Pressure Diagram

- Press **START TEST** to start the measurement.

After that a leakage test as described in chapter 5.5 will be performed.

With the Wöhler DP 600 the user can perform a differential pressure test. To do so select **DIF-FERENTIAL PRESSURE** in the menu.

A diagram as shown on the left will appear that shows the differential pressure of the last 4 minutes. The diagram can be stopped and printed.



**NOTE!**

It is not possible to save the results of the differential pressure test.

## 7 4 PA-Test

The Wöhler DP 600 Leakage Tester can perform the 4 Pa-test to control the underpressure limit 4 Pa. The 4 Pa test controls if there is a sufficient combustion air supply according to the DVGW (German Association of Gas and Water Engineers), Note G 625. The test measures the differential pressure between the room where the fireplace is installed and the ambient air, when the theoretically required combustion air is withdrawn. The Wöhler DP 600 sucks the theoretically required combustion air and this way simulates the fireplace. At the same time the instrument measures the differential pressure. No additional measuring instrument will be necessary for the 4 Pa test.



### WARNING!

Switch off the fireplace.

### 7.1 Preparations for the 4 Pa test

- Select **4 Pa TEST** in the main menu.
- Select **STANDARD PROCEDURE** or **ENHANCED PROCEDURE**.

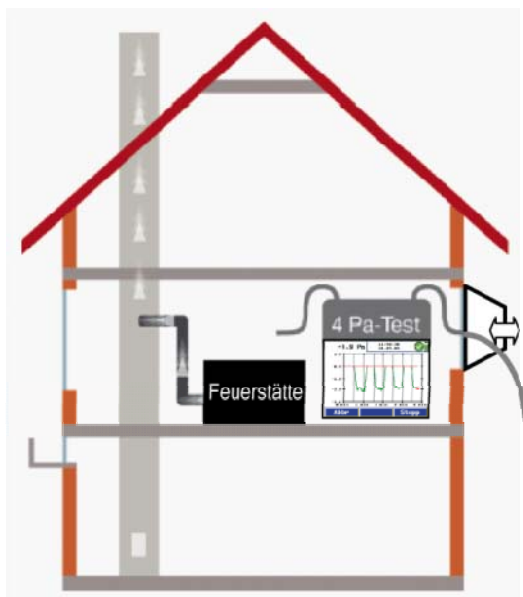

Fig. 35: standard procedure

For the standard procedure the fireplace has to be connected to the exhaust gas system.

<b>4Pa-TEST</b>	13:42:32 7.01.2013
<b>PROCEDURE</b>	<b>: standard</b>
OUTPUT POWER :	0.0 kW
OUTSIDE TEMP. :<	0°C
<b>START TEST</b>	
FLOW :	0.0 m <sup>3</sup> /h
<b>BACK</b>	↑ ↓ →

Fig. 36: Display, standard procedure

The user can directly proceed to prepare the measurement.

<b>4Pa-TEST</b>	13:43:36 7.01.2013
<b>PROCEDURE</b>	<b>: enhanced</b>
OUTPUT POWER :	7.0 kW
OUTSIDE TEMP. :<	0°C
<b>START TEST</b>	
FLOW :	14.0 m <sup>3</sup> /h
<b>BACK</b>	↑ ↓ →

Fig. 37: Display, enhanced procedure

- If the user has selected the enhanced procedure, he must enter the output power of the installation and the outside temperature before starting the measurement.

## 4 PA-Test

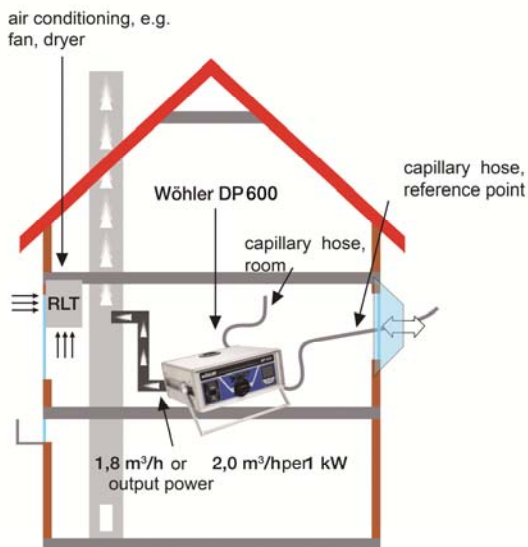

Fig. 38: Enhanced procedure

- For the enhanced procedure, the Wöhler DP 600 has to be connected to the fireplace in place of the exhaust gas system.
- Remove the connecting piece of the fireplace and connect the plastic hose class N with a suitable Sealing Element to the exhaust gas system.



### WARNING!

Make sure that there is no adaptor installed in the Wöhler DP 600.

- Plug the free end of the plastic hose to the air connection (over pressure) (Fig. 1, part 11).

During the 4 Pa test the measuring instrument will suck a constant amount of air from the fireplace room.



### NOTE!

When applying the enhanced or the standard procedure, it is necessary to open and to close the window as described later in this chapter.



Fig. 39: Wöhler DP 600 with capillary hoses during the 4 PA test.

When applying the standard procedure or the enhanced procedure proceed as follows.

- Connect the capillary hose, that leads to the reference point (stairway or outside air), to the negative pressure socket (fig. 1, part 5).



### NOTE!

First remove the connection plug of the end of the black capillary hose, so that you can plug the hose to the hose nipple of the negative pressure socket (fig. 1. part 5).

- Connect the second capillary hose to the positive pressure socket (fig. 1, part 4). The second hose stays in the room where the fireplace is installed. With this hose the march of pressure will be recorded.

Underpressure in the fireplace room in relation to the pressure at the reference point will lead to a negative differential pressure.

## 7.2 Performing the 4 Pa test

How to perform the 4 Pa Pressure Test:

- Switch on appliance and all air conditioning (fan, dryer) with maximum power.
- Open an outside window or a door to the reference room and test proper operation of the appliance, ensure that there are no back-draft conditions.
- How to position the reference capillary hose: Lead the hose outside through a window seal or into the stairways through the door rebate or the keyhole.



### NOTE!

*Especially on stormy days, the stairways may be a stable reference room.*

*If the stairways are used as reference room, all windows, doors, cellar doors and trap doors have to be closed.*

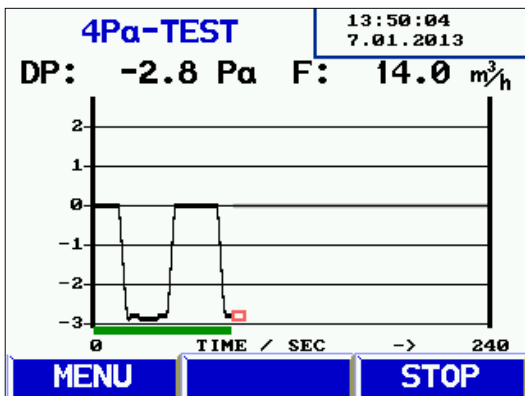

Fig. 40: Pressure profile during the 4 Pa Test

The second capillary hose will stay uncut in the fireplace room.

- Reset the pressure sensor by pressing „P<sub>D</sub> = 0“ (standard procedure) or enter the data of the fireplace and the outside temperature (enhanced procedure).
- Press "Start" to start the 4-PA Test. The meter will now record the pressure profile for 4 minutes.
- Open the window/door for about 30 seconds, so that the zero line can be registered.
- Close the window/door for about 30 seconds, control underpressure.
- Open the window/door for about 30 seconds, the zero line should be reached again.
- Close the window/door for about 30 seconds, control underpressure.
- Open the window/door for about 30 seconds, the zero line should be reached again.
- Close the window/door for about 30 seconds,

control underpressure.

For a better orientation, every 30 seconds there are auxiliary lines in the diagram. After a maximum of 4 minutes, the measurement will stop automatically.



**NOTE!**

Press "Stop" to stop the 4 PA Test earlier.

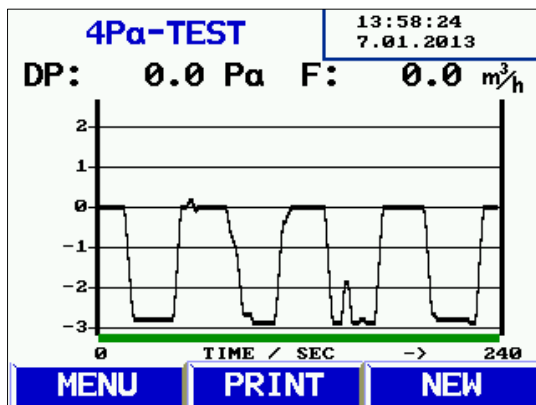

Fig. 41: Diagram 4 Pa Test

Normally a diagram as shown in figure on the left will appear. The pressure peaks in the diagram are caused by the rapid movement of the window or the door and therefore they are not relevant for the interpretation of the diagram.

In the figure on the left the pressure drop is about 2,0 Pa.

The reliability of the system is considered sufficient, when the pressure drop caused by opening and closing the window is less or equal to 4 Pa (8 Pa in the case of wood burning without surrounding air).

After the 4 Pa test is completed, "4 Pa Test" will be marked by "4PA" in the main menu. Select "Print" from the main menu to print out the readings and select "Save measurements" to save them.

## 8 Stove Test

The Wöhler DP 600 can be used to control the tightness of a stove. According to the approval guidelines for the control of room sealed appliances, the requirements regard the leak tightness of fireplaces with its necessary access lines for the combustion air and the connection.

To control the leak tightness of a fireplace, the same procedure to control the leak tightness of an exhaust gas system class N is applied. If possible use the Sealing Set Type N and connect it as described in chapter 5.3) for the leakage test. You can purchase Sealing Elements of many different forms and sizes. Nevertheless it may be necessary to adapt the Sealing Element to the test object. In this case we recommend to use Sealing Elements that can be cut individually. (see accessories).

Always install the adapter 3,0 for the stove test.

### 8.1 Performing the Stove Test

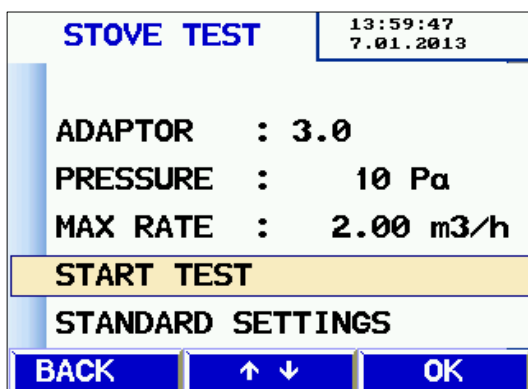

Fig. 42: Presetting for the Stove Test

- In the main menu, select **STOVE TEST**.

In the following display, enter the measurement configuration. The figure on the left shows the pre-setting.



#### **WARNING!**

Make sure that the adapter 3,0 is installed in the Wöhler DP 600.

Connect the large air tube and the small pressure tube to the test object and start the measurement.

The measurement is the same as for the leakage test. The Wöhler DP 600 will automatically determine the leakage rate of the test object.

## 9 SETUP

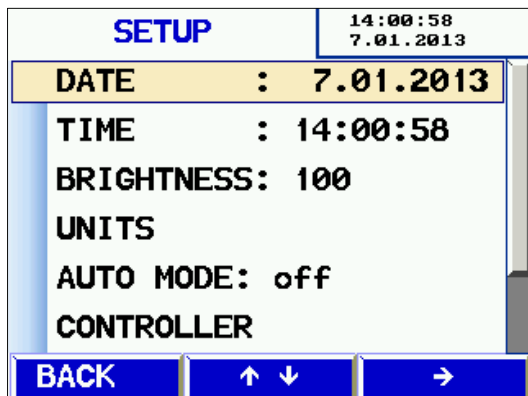

Fig. 43: Setup menu, upper display

Date

Change the current date of the internal calendar (format 1.01.2013)

Time

Change the current time of the internal clock (format 12:00:00 AM)

Brightness

Adjust the brightness of the display between 0 % and 100 %.

Units

Select the unit.

Pressure

Pa, hPa, mbar, mm/H<sub>2</sub>O, in/Wc

Flow rate (to enter for all adapters):

m<sup>3</sup>/h, CFM, l/sm<sup>2</sup>, l/h, l/min, l/s

Auto Mode

If the auto mode is activated, the Wöhler DP 600 will perform a complete measurement after it has been switched on. In this case the user does not have to enter anything.

The following statuses are possible:

off normal mode

std The Wöhler DP 600 will automatically perform a measurement in the standard mode with the last configuration.

Var The Wöhler DP 600 will automatically perform a measurement in the variable mode with the last configuration.

- Go to the main menu.  
Select the option "SETUP" to enter the main setup menu. Proceed as follows:

- Use the arrow keys to select and change the parameters.

The parameter that can be changed appears in red.

- Press BACK to leave the parameter without saving or press the down-key to save the new setting and go to the next parameter.



Controller	<p>The Wöhler DP 600 works with a PI controller. Normally there is no need for the user to adapt the parameters of the controller. If the exhaust gas system to be tested is especially large or small, the user will have the possibility to adapt the controller.</p> <p>He can determine the reset time <math>T_N</math> between 0,1 and 300 s.</p> <p>He can determine the boost <math>K_P</math> between 0 and 20.000.</p>
Default	<p>Reset the Wöhler DP 600 to its factory default setting (except the calibration).</p>
Printer logo	<p>Enter a custom corporate logo (6 lines) that will appear in every printout.</p>

## 10 Data management

- The user can create a folder for every client and assign up to 100 legs to a client.

### 10.1 Save customer records

<b>SAVE</b>		14:02:42 7.01.2013
NAME	:	Kunde 3
NUMBER	:	3
<b>NEW LEG</b>		
STRANG 1	D.I. 4Pa	6.11.2012
<b>BACK</b>	↑ ↓	<b>OK</b>

Fig. 44: Riser selection

When different measurements have been performed at one installation, they can be assigned to a client as follows:

- Select the **SAVE** option from the main menu.
- Use the up- and down keys to navigate through the menu. If there exists no folder of the customer, whose data shall be saved, yet in the Wöhler DP 600 it can be created in the "new customer" menu (see chapter 0).



**NOTE!**

*Keep the up or down key depressed to scroll faster.*

- Confirm with **OK** .
- The list of legs will appear. Select "NEW LEG " to assign a new leg to this client.
- Confirm with **OK** .



**NOTE!**

*During the saving process, the data that has already been saved before under this leg, will be deleted.*

## 10.2 Creating a new customer folder

Fig. 45: Creating a new customer folder

Fig. 46: New Customer

The user can create new customer folders or new legs when saving the data.

- Go to the main menu and select **SAVE**.

All customers will appear and the option NEW CUSTOMER.

- Select NEW CUSTOMER.
- Select CREATE NEW RECORD.

With the arrow keys, enter the name, a customer number and the name of the leg.



### NOTE!

The user can save all together 100 legs and assign them to different customers. The number of legs assigned to a customer is arbitrary.

## 10.3 Option "Data management"

Fig. 47: Option "Data management"

Select "PRINT REPORT" to print a report of any saved measurement.

Select "DELETE LEG" to delete a single leg.



### NOTE!

When there is only one leg saved in a customer folder, the customer folder will be deleted when the riser is deleted.

Select "DELETE CUSTOMER" to delete a complete customer folder with all risers.

Select "DELETE ALL" to delete all customer folders.

## 11 Data transfer with the PC or notebook

The data can be transferred from the Wöhler DP 600 to a PC or notebook with the USB cable. To do so the Software Wöhler DC 4xx/DP 600 is needed.

- Connect the USB cable to the USB port of the Wöhler DP 600 (fig. 1, part 7) and the other end of the cable to the USB port of the PC.

•

## 12 Calibration

### **!** ATTENTION!

Only authorized Wöhler Service employees may calibrate the device. Improper changes may lead to incorrect results.

This menu can only be entered with a pass word.

## 13 Info

Go to the main menu and select INFO.

In the display the number of measurement cycles, the hours of operation, the date of manufacture, the calibration date and the firmware version are shown.

INFO		14:09:25 7.01.2013
CYCLES	: 176	
HOURS	: 12:56	
PRODUCED	: 30.04.2012	
CALIBRATED:	2.07.2012	
FIRMWARE	:V1.04	
	(05.11.2012)	
BACK	↑ ↓	

Fig. 48: Information

•

## 14 Fault indication

Error message	Possible reason	Solution
self test error (pressure)	Pressure on the line/storm	Switch off the device and start again
	Pressure sensor damaged	Send the instrument to a Wöhler service point
self test error (flow)	Pressure on the line/storm	Switch off the device and start again
	Flow sensor damaged	Send the instrument to a Wöhler service point
Overheat	Overheat	Remove adapter and let the instrument cool down to room temperature.

## 15 Maintenance

The Wöhler DP 600 does not contain any parts that can be serviced. Therefore the instrument should never be opened by the user.





### **WARNING!**

The instrument may only be opened by a Wöhler Service Employee.

Caution - Risk of death due to electric current!  
230V 50 Hz

### 15.1 Maintenance work

Interval	Maintenance work
Depends on the usage, but at least once a year	Slightly grease all o-rings of the pressure and air connection and of the adapters.
In case of pollution	Change the filter pads in the air connection - under pressure
If necessary	change the primary fuse - Disconnect the power cord from the wall socket. - Remove the fuse holder by pulling the upper edge.
 <b>ATTENTION!</b> Only replace the fuse by another of the same type.	
Once a year	Control and Calibration of the instrument by Wöhler or an authorized service point.
 <b>ATTENTION!</b> Only Wöhler service employees can calibrate the Wöhler DP 600 in the factory.	

## **16 Warranty and Service**

### **16.1 Warranty**

Each Wöhler DP 600 Leakage Tester will be tested in all functions and will leave our factory only after extensive quality control testing. The final control will be recorded in detail in a test report and delivered with any unit.

If used properly, the warranty period for the Wöhler DP 600 will be twelve month from the date of sale. Wear parts, e.g. filters are not covered by this warranty.

This warranty does not cover the freight and packing costs when the device is sent to the factory for repair.

Service by non authorized personnel or making modifications to the analyzer voids any warranty.

### **16.2 Service**

Wöhler has built our reputation on excellence in customer service. Therefore, of course, we are readily available to assist you after the warranty period ends.

- Send us the device and we will repair it and return it to you with our package service.
- Immediate help is provided by our technical staff over the telephone.

## 17 Accessories

### Printer

Wöhler TD 100 Thermal Printer Order no. 4160

### Cases

Universalbox Order no. 50784

Plastic Case Wöhler DP 600 Order no. 2634

### Sealing Sets

Wöhler DP 600 Sealing Set Type P + H  
for 200 and 5.000 Pa measurements Order no. 2601

Sealing Element with hole 110 - 150 mm Order no. 3843

Extension tube 3,75 m for Ø 50 mm Order no. 50676

Wöhler DP 600 Sealing Set Type N  
for 20 and 40 Pa measurements Order no. 2602

### Sealing Bladder with double gas lead through

Ø 50 – 150 mm Order no. 7973

Ø 150 – 350 mm Order no. 7974

Ø 350 – 600 mm Order no. 7966

### Sealing Bladder without gas lead through

Ø 50 – 150 mm Order no. 7970

Ø 150 – 350 mm Order no. 7971

Ø 350 – 600 mm Order no. 7981

### Sealing Elements

Sealing Element Set Square Order no. 8220

Sealing Element Set Round Order no. 8050

Sealing Element to be cut individually Order no. 50783

### 4-Pa Test

Wöhler DP 600 Flexible Capillary, 6 m Best. Order no.  
2604

### Software

Software CD Wöhler DC 4xx / DP 600 Order no. 997



## 18 Declaration of Conformity

The manufacturer:

Wöhler Messgeräte Kehrgeräte GmbH  
Schützenstr. 41, D-33181 Bad Wünnenberg

declares that the product

product name: Leakage Tester  
model number: Wöhler DP 600

complies with the key safety requirements set down in the guidelines of the Council for the Harmonization of the Legal Requirements of the Member States in relation to the electromagnetic compatibility 2004/108/EG and the low voltage 2006/95/EG.

The following standards were availed of to evaluate the product in respect of the electromagnetic compatibility:

EN 61000 (electromagnetic compatibility EMC)  
EN 55011, classe B, EN 55014, EN 55016, EN 55022 (radio interference)

Bad Wünnenberg, 11.07.2012

Dr. Stephan Ester, Managing director  
Wöhler Messgeräte Kehrgeräte GmbH

## 19 Brief instruction: Leakage Test

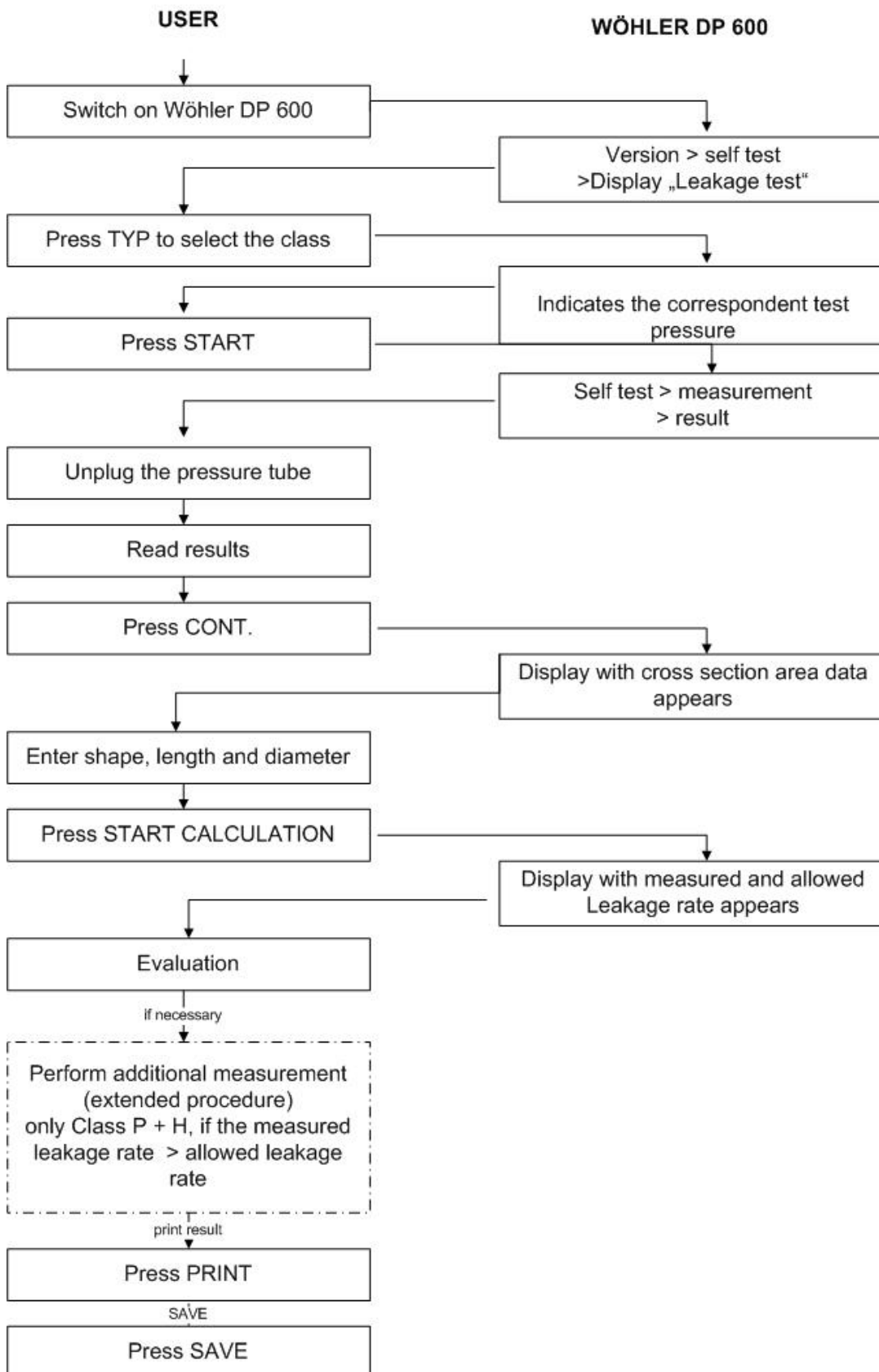

## Points of sale and service

### Germany

#### **Wöhler Messgeräte Kehrgeräte GmbH**

Schützenstr. 41  
33181 Bad Wünnenberg  
Tel.: +49 2953 73-100  
Fax: +49 2953 73-96100  
mgkg@woehler.de  
www.mgkg.woehler.de

#### **Wöhler West**

Castroper Str. 105  
44791 Bochum  
Tel.: +49 234 516993-0  
Fax: +49 234 516993-99  
west@woehler.de

#### **Wöhler Süd**

Gneisenastr.12  
80992 München  
Tel.: +49 89 1589223-0  
Fax: +49 89 1589223-99  
sued@woehler.de

### International

#### **USA**

Wöhler USA Inc.  
5 Hudchinson Drive (rear)  
Danvers, MA 01923  
Tel.: +1 978 750 9876  
Fax.: +1 978 750 9799  
www.woehlerusa.com

#### **Czech Republic**

Wöhler Bohemia s.r.o.  
Za Naspem 1993  
393 01 Pelhrimov  
Tel.: +420 5653 49019  
Fax: +420 5653 23078  
info@woehler.cz

#### **Italy**

Wöhler Italia srl  
Corso Libertà 9  
39100 Bolzano  
Tel.: +390471402422  
Fax: +39 0471  
www.mgkg.woehler.it

#### **France**

Wöhler France SARL  
16 Chemin de Fondeyre  
31200 Toulouse  
Tel. : 05 61 52 40 39  
Fax : 05 62 27 11 31  
info@woehler.fr  
www.mgkg.woehler.fr

**Your contact:**